

TL Series

High Performance
Low Pressure Drop Heat Sink

ALPHA

ALPHA High Performance Low Pressure Drop Heat Sink

TL19

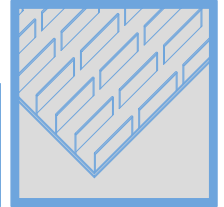

DIM

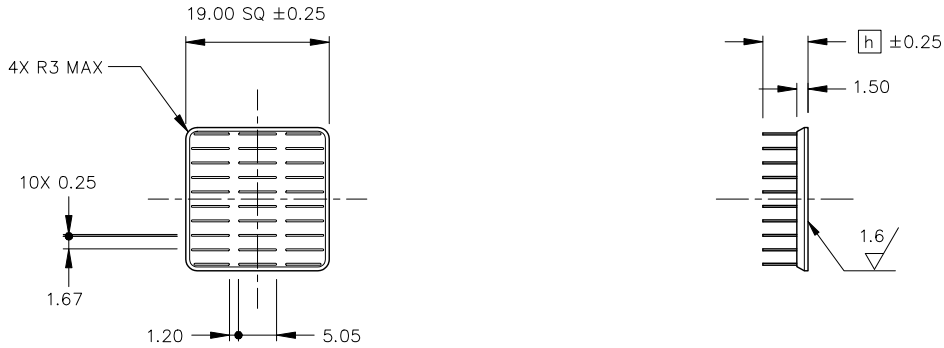

MATERIAL : A6063
 FINISH : BLACK ANODIZE
 DIMENSIONS : mm

MODEL	HEIGHT [h]	WEIGHT (grams)
TL19-4B	4	1.7
TL19-5B	5	1.8
TL19-6B	6	1.9

DATA

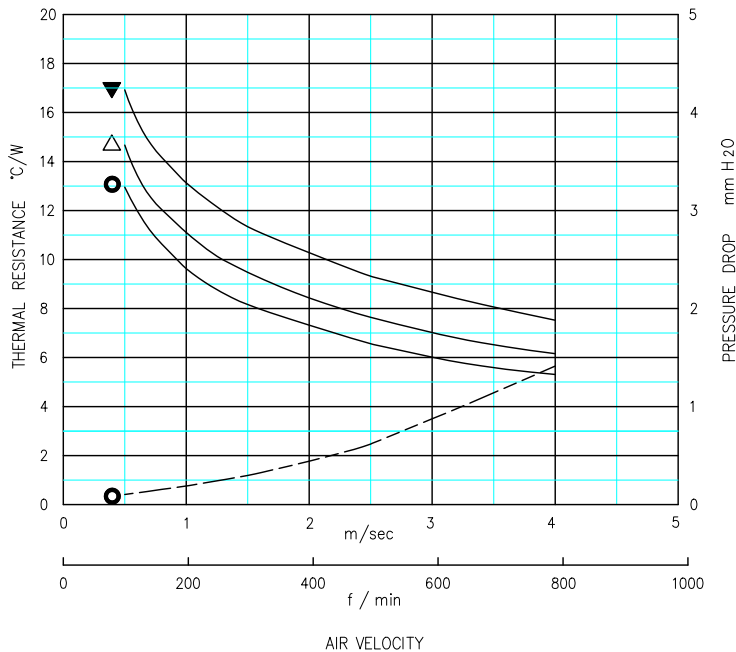

- ▼ TL19-4B
- △ TL19-5B
- TL19-6B
- DUCTED CONDITION
- DUMMY HEATER SIZE: 12.7 SQ
- THERMAL RESISTANCE
- - - PRESURE DROP

BASED ON ALPHA'S STANDARD TEST PROCEDURE.
 REFER TO TECHNICAL INFORMATION.

Alpha Company Ltd.

256-1 UEDA, NUMAZU-CITY SHIZUOKA-PREF., JAPAN
 PHONE +81(55)966 0789
 FAX +81(55)966 9192
 E mail : alpha@micforg.co.jp
 URL : <https://www.micforg.co.jp>

Alpha Novatech, Inc. - a subsidiary of Alpha Company.

473 Sapena Ct. #12 Santa Clara, CA 95054 USA
 PHONE +1(408)567-8082
 FAX +1(408)567-8053
 E mail : sales@alphanovatech.com
 URL : <https://www.alphanovatech.com>

ALPHA High Performance Low Pressure Drop Heat Sink

TL25

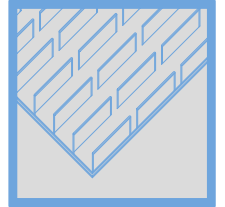

DIM

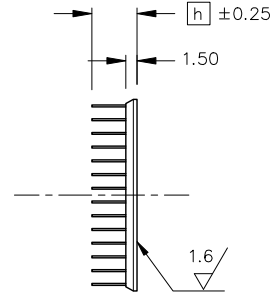
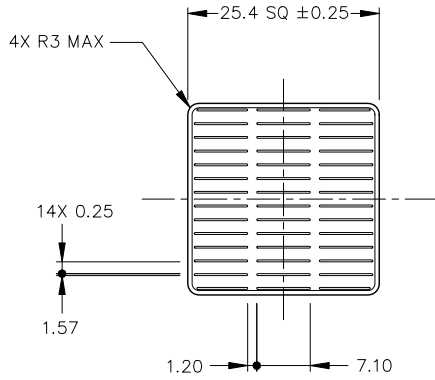

MATERIAL : A6063
 FINISH : BLACK ANODIZE
 DIMENSIONS : mm

MODEL	HEIGHT [h]	WEIGHT (grams)
TL25-4B	4	3.1
TL25-5B	5	3.3
TL25-6B	6	3.5

DATA

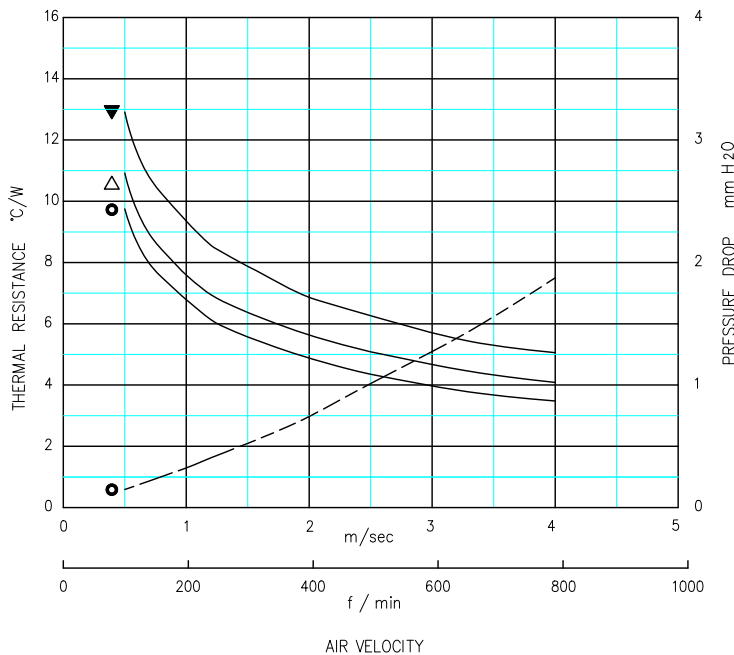

- ▼ TL25-4B
- △ TL25-5B
- TL25-6B
- DUCTED CONDITION
- DUMMY HEATER SIZE: 12.7 SQ
- THERMAL RESISTANCE
- - - PRESURE DROP

BASED ON ALPHA'S STANDARD TEST PROCEDURE.
 REFER TO TECHNICAL INFORMATION.

Alpha Company Ltd.

256-1 UEDA, NUMAZU-CITY SHIZUOKA-PREF., JAPAN
 PHONE +81(55)966 0789
 FAX +81(55)966 9192
 E mail : alpha@micforg.co.jp
 URL : <https://www.micforg.co.jp>

Alpha Novatech, Inc. - a subsidiary of Alpha Company.

473 Sapena Ct. #12 Santa Clara, CA 95054 USA
 PHONE +1(408)567-8082
 FAX +1(408)567-8053
 E mail : sales@alphanovatech.com
 URL : <https://www.alphanovatech.com>

ALPHA High Performance Low Pressure Drop Heat Sink

TL30

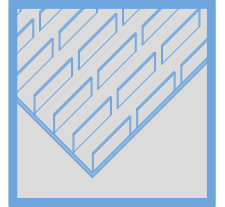

DIM

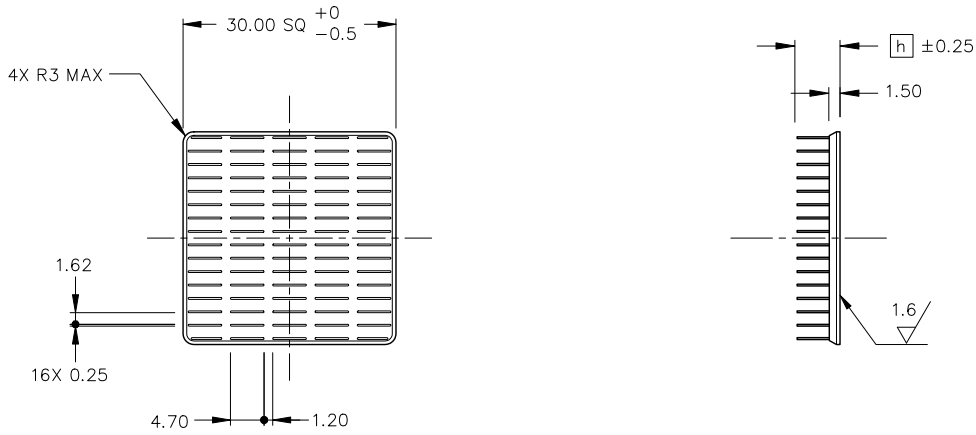

MATERIAL : A6063
 FINISH : BLACK ANODIZE
 DIMENSIONS : mm

MODEL	HEIGHT [h]	WEIGHT (grams)
TL30-4B	4	4.2
TL30-5B	5	4.5
TL30-6B	6	4.7

DATA

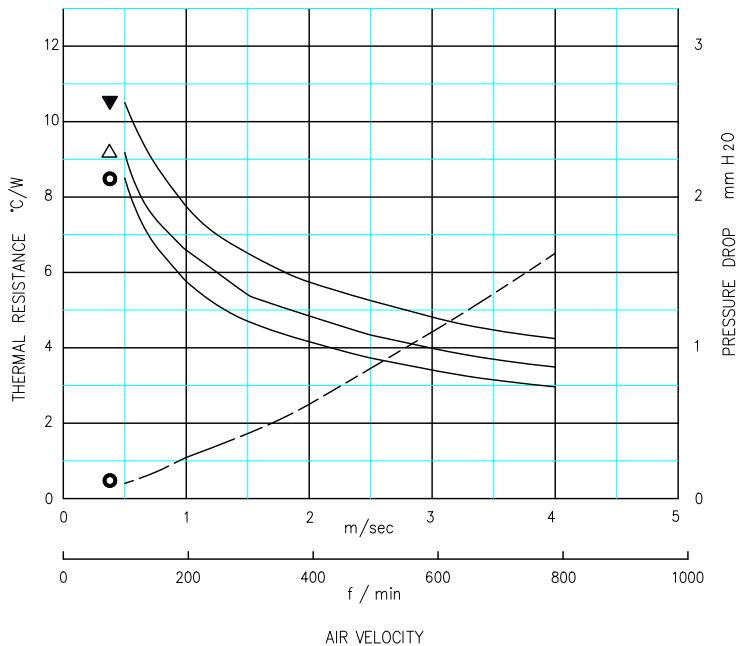

▼ TL30-4B
 △ TL30-5B
 ● TL30-6B
 ● DUCTED CONDITION
 ○ DUMMY HEATER SIZE: 12.7 SQ
 — THERMAL RESISTANCE
 - - - PRESSURE DROP

■ BASED ON ALPHA'S STANDARD TEST PROCEDURE.
 REFER TO TECHNICAL INFORMATION.

Alpha Company Ltd.

256-1 UEDA, NUMAZU-CITY SHIZUOKA-PREF., JAPAN
 PHONE +81(55)966 0789
 FAX +81(55)966 9192
 E mail : alpha@micforg.co.jp
 URL : <https://www.micforg.co.jp>

Alpha Novatech, Inc. - a subsidiary of Alpha Company.

473 Sapena Ct. #12 Santa Clara, CA 95054 USA
 PHONE +1(408)567-8082
 FAX +1(408)567-8053
 E mail : sales@alphanovatech.com
 URL : <https://www.alphanovatech.com>

ALPHA High Performance Low Pressure Drop Heat Sink

TL35

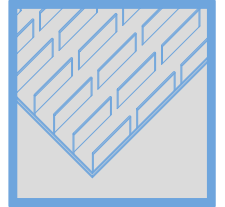

DIM

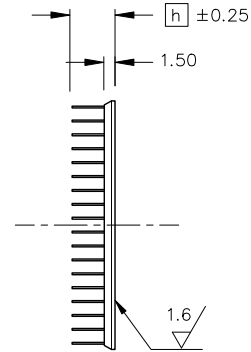
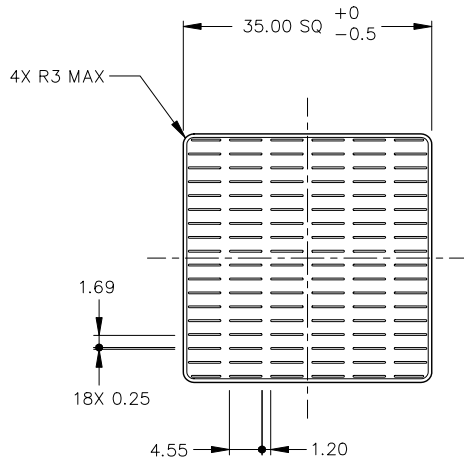

MATERIAL : A6063
 FINISH : BLACK ANODIZE
 DIMENSIONS : mm

MODEL	HEIGHT [h]	WEIGHT (grams)
TL35-4B	4	5.7
TL35-5B	5	6.0
TL35-6B	6	6.4

DATA

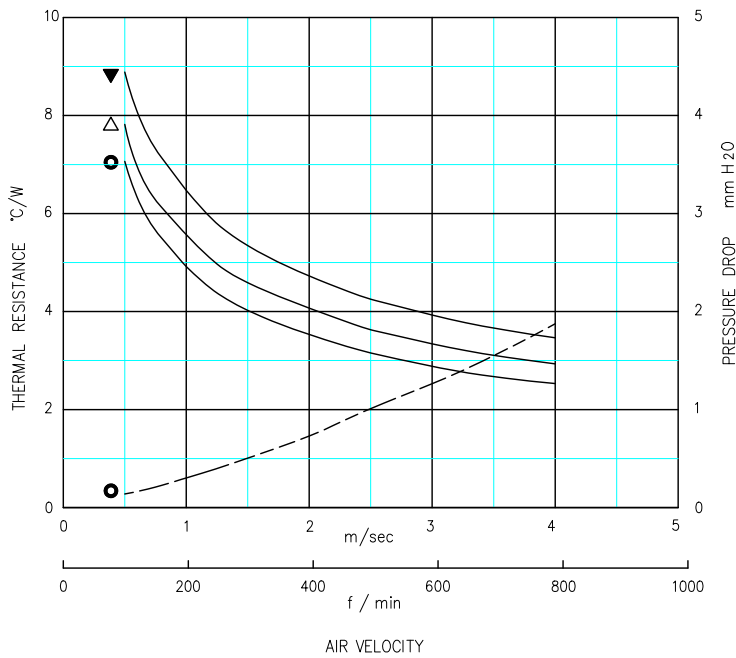

- ▼ TL35-4B
- △ TL35-5B
- TL35-6B
- DUCTED CONDITION
- DUMMY HEATER SIZE: 12.7 SQ
- THERMAL RESISTANCE
- - - PRESSURE DROP

■ BASED ON ALPHA'S STANDARD TEST PROCEDURE.
 REFER TO TECHNICAL INFORMATION.

Alpha Company Ltd.

256-1 UEDA, NUMAZU-CITY SHIZUOKA-PREF., JAPAN
 PHONE +81(55)966 0789
 FAX +81(55)966 9192
 E mail : alpha@micforg.co.jp
 URL : <https://www.micforg.co.jp>

Alpha Novatech, Inc. - a subsidiary of Alpha Company.

473 Sapena Ct. #12 Santa Clara, CA 95054 USA
 PHONE +1(408)567-8082
 FAX +1(408)567-8053
 E mail : sales@alphanovatech.com
 URL : <https://www.alphanovatech.com>

ALPHA High Performance Low Pressure Drop Heat Sink

TL40

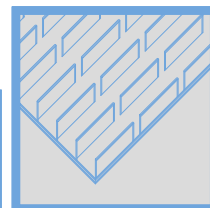

DIM

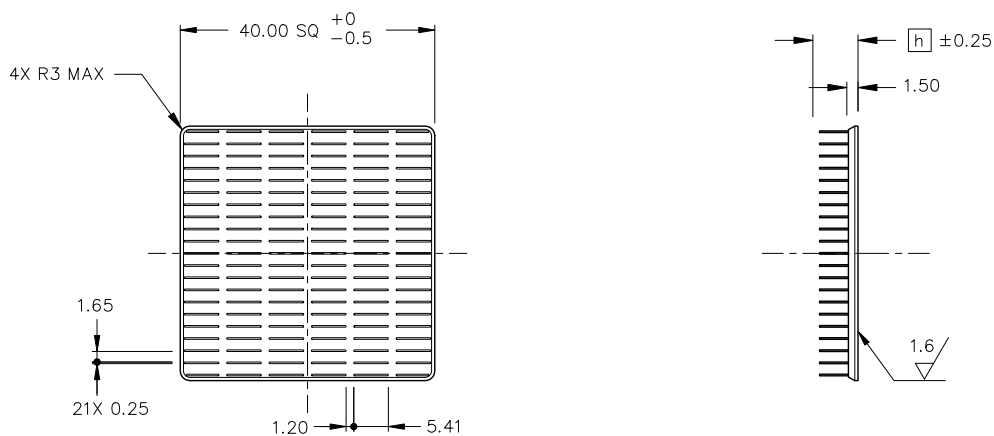

MATERIAL : A6063
 FINISH : BLACK ANODIZE
 DIMENSIONS : mm

MODEL	HEIGHT [h]	WEIGHT (grams)
TL40-4B	4	7.5
TL40-5B	5	8.0
TL40-6B	6	8.4

DATA

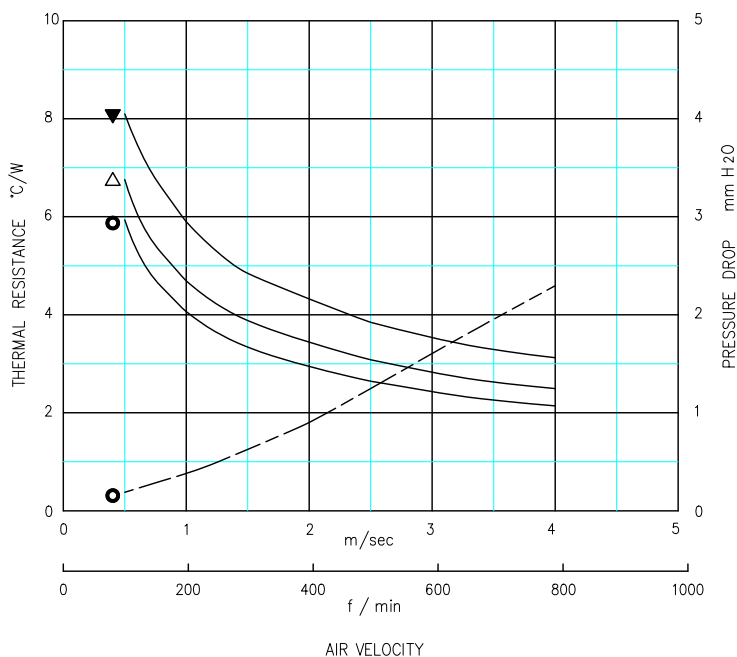

- ▼ TL40-4B
- △ TL40-5B
- TL40-6B
- DUCTED CONDITION
- DUMMY HEATER SIZE: 12.7 SQ
- THERMAL RESISTANCE ———
- PRESURE DROP - - - -

■ BASED ON ALPHA'S STANDARD TEST PROCEDURE.
 REFER TO TECHNICAL INFORMATION.

Alpha Company Ltd.

256-1 UEDA, NUMAZU-CITY SHIZUOKA-PREF., JAPAN
 PHONE +81(55)966 0789
 FAX +81(55)966 9192
 E mail : alpha@micforg.co.jp
 URL : <https://www.micforg.co.jp>

Alpha Novatech, Inc. - a subsidiary of Alpha Company.

473 Sapena Ct. #12 Santa Clara, CA 95054 USA
 PHONE +1(408)567-8082
 FAX +1(408)567-8053
 E mail : sales@alphanovatech.com
 URL : <https://www.alphanovatech.com>