

ZZ Series

Ultra - High Performance Heat Sink
For Z-Shaped CLIP / QSZ CLIP

ALPHA

ALPHA

Ultra - High Performance Heat Sink
For Z-Shaped CLIP / QSZ CLIP

ZZ40

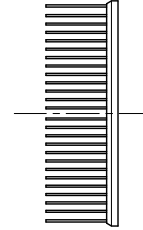
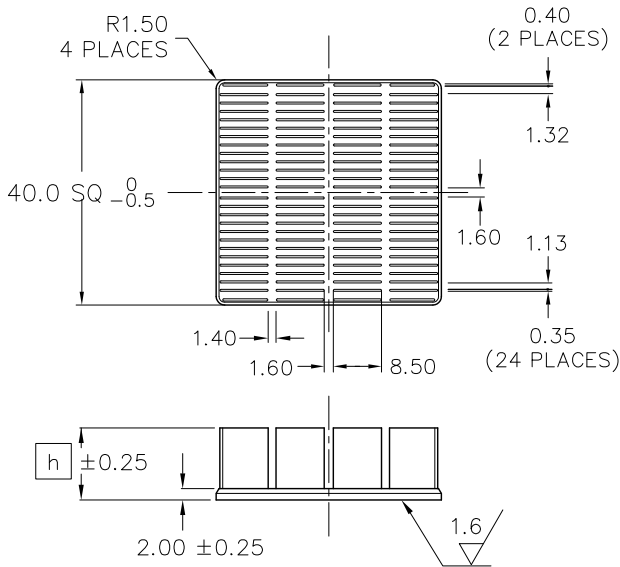
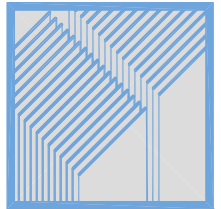

HEAT SINK
MATERIAL : A 6063
FINISH : BLACK ANODIZE

MODEL	HEIGHT h	WEIGHT (grams)
ZZ40-6.3B	6.3	12.0
ZZ40-9.5B	9.5	14.6
ZZ40-12.7B	12.7	17.3

Dimensions : mm

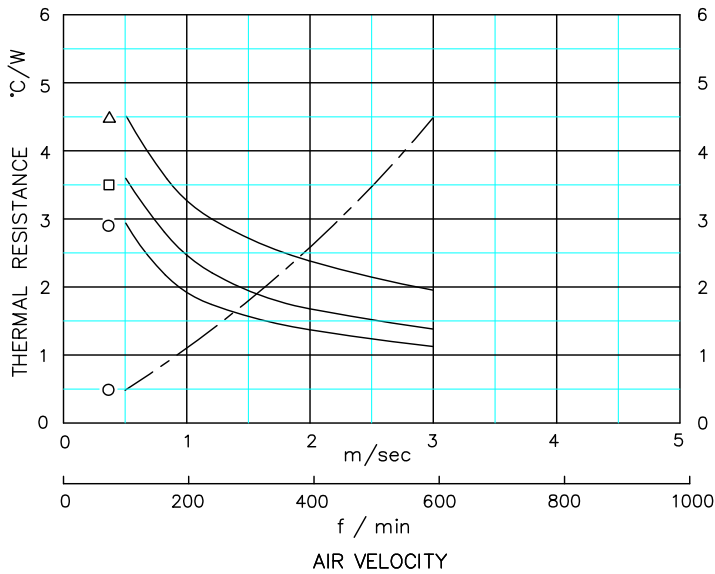

- △ ZZ40-6.3B
- ZZ40-9.5B
- ZZ40-12.7B

● DUCTED CONDITION
DUMMY HEATER SIZE: 12.7 SQ
THERMAL RESISTANCE ———
PRESURE DROP - - - - -

■ BASED ON ALPHA'S STANDARD TEST PROCEDURE.
REFER TO TECHNICAL INFORMATION.

Alpha Company Ltd.

256-1 UEDA, NUMAZU-CITY SHIZUOKA-PREF., JAPAN
PHONE +81(55)966 0789
FAX +81(55)966 9192
E mail : alpha@micforg.co.jp
URL : http://www.micforg.co.jp

Alpha Novatech, Inc. - a subsidiary of Alpha Company.

473 Sapena Ct. #12 Santa Clara, CA 95054 USA
PHONE +1(408)567-8082
FAX +1(408)567-8053
E mail : sales@alphanovatech.com
URL : http://www.alphanovatech.com

ALPHA

Ultra - High Performance Heat Sink
For Z-Shaped CLIP / QSZ CLIP

ZZ45

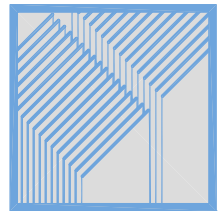

DIM

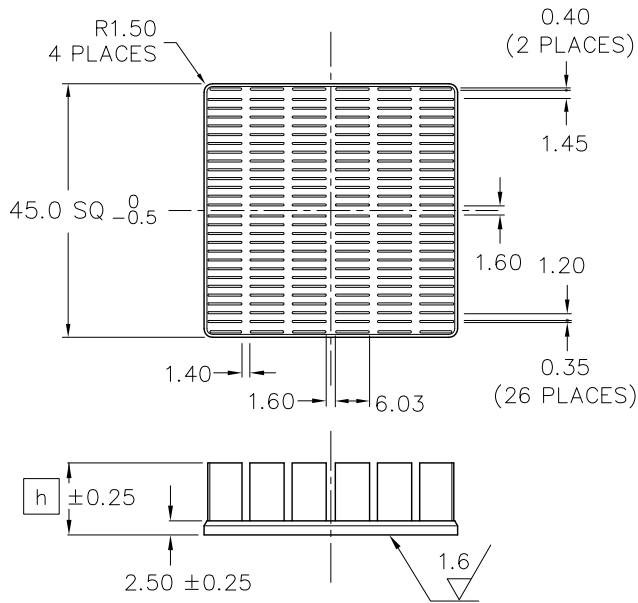

MODEL	HEIGHT h	WEIGHT (grams)
ZZ45-6.3B	6.3	17.0
ZZ45-9.5B	9.5	20.0
ZZ45-12.7B	12.7	23.1

Dimensions : mm

HEAT SINK
MATERIAL : A 6063
FINISH : BLACK ANODIZE

DATA

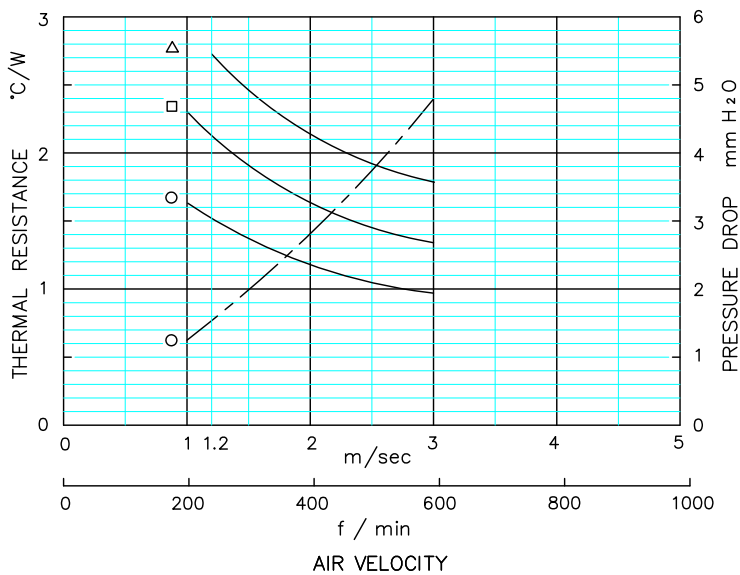

- △ ZZ45-6.3B
- ZZ45-9.5B
- ZZ45-12.7B

● DUCTED CONDITION
DUMMY HEATER SIZE: 12.7 SQ
THERMAL RESISTANCE ———
PRESURE DROP - - - - -

■ BASED ON ALPHA'S STANDARD TEST PROCEDURE.
REFER TO TECHNICAL INFORMATION.

Alpha Company Ltd.

256-1 UEDA, NUMAZU-CITY SHIZUOKA-PREF., JAPAN
PHONE +81(55)966 0789
FAX +81(55)966 9192
E mail : alpha@micforg.co.jp
URL : <http://www.micforg.co.jp>

Alpha Novatech, Inc. - a subsidiary of Alpha Company.

473 Sapena Ct. #12 Santa Clara, CA 95054 USA
PHONE +1(408)567-8082
FAX +1(408)567-8053
E mail : sales@alphanovatech.com
URL : <http://www.alphanovatech.com>

ALPHA

Ultra - High Performance Heat Sink
For Z-Shaped CLIP / QSZ CLIP

ZZ50

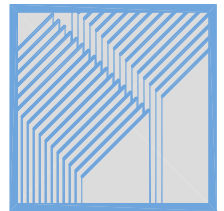

DIM

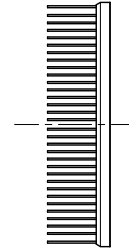
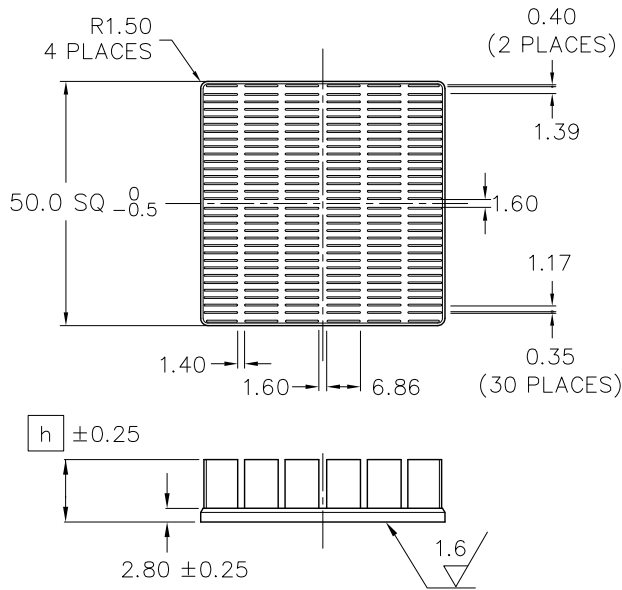

HEAT SINK
MATERIAL : A 6063
FINISH : BLACK ANODIZE

MODEL	HEIGHT h	WEIGHT (grams)
ZZ50-6.3B	6.3	22.8
ZZ50-9.5B	9.5	26.8
ZZ50-12.7B	12.7	30.8

Dimensions : mm

DATA

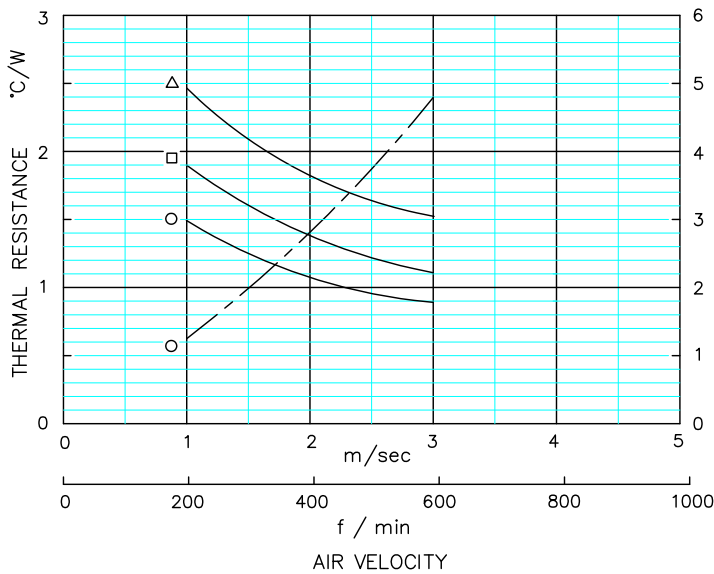

- △ ZZ50-6.3B
- ZZ50-9.5B
- ZZ50-12.7B

● DUCTED CONDITION
DUMMY HEATER SIZE: 12.7 SQ
THERMAL RESISTANCE ———
PRESURE DROP - - - - -

■ BASED ON ALPHA'S STANDARD TEST PROCEDURE.
REFER TO TECHNICAL INFORMATION.

Alpha Company Ltd.

256-1 UEDA, NUMAZU-CITY SHIZUOKA-PREF., JAPAN
PHONE +81(55)966 0789
FAX +81(55)966 9192
E mail : alpha@micforg.co.jp
URL : http://www.micforg.co.jp

Alpha Novatech, Inc. - a subsidiary of Alpha Company.

473 Sapena Ct. #12 Santa Clara, CA 95054 USA
PHONE +1(408)567-8082
FAX +1(408)567-8053
E mail : sales@alphanovatech.com
URL : http://www.alphanovatech.com

ALPHA

Ultra - High Performance Heat Sink
For Z-Shaped CLIP / QSZ CLIP

ZZ54

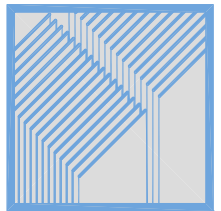

DIM

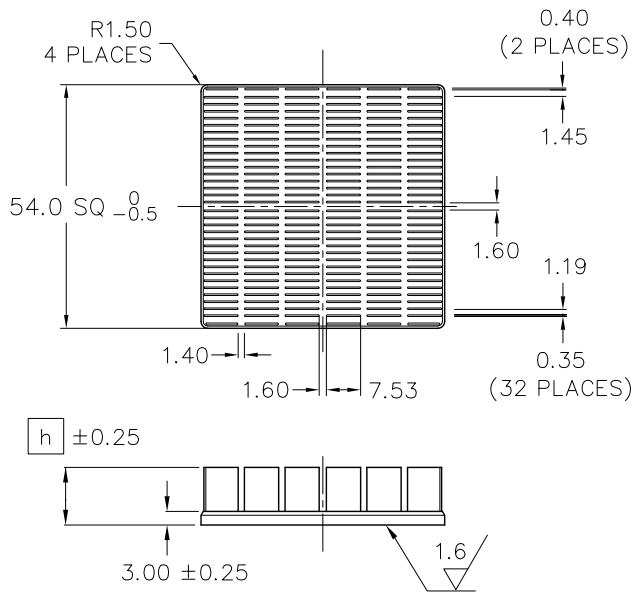

MODEL	HEIGHT h	WEIGHT (grams)
ZZ54-6.3B	6.3	28.0
ZZ54-9.5B	9.5	32.6
ZZ54-12.7B	12.7	37.2

Dimensions : mm

HEAT SINK
MATERIAL : A 6063
FINISH : BLACK ANODIZE

DATA

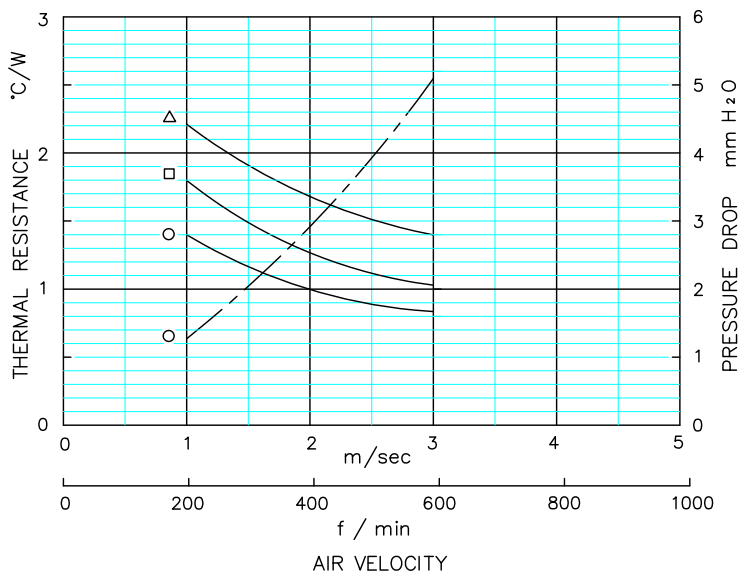

- △ ZZ54-6.3B
- ZZ54-9.5B
- ZZ54-12.7B

● DUCTED CONDITION
DUMMY HEATER SIZE: 12.7 SQ
THERMAL RESISTANCE ———
PRESURE DROP - - - - -

■ BASED ON ALPHA'S STANDARD TEST PROCEDURE.
REFER TO TECHNICAL INFORMATION.

Alpha Company Ltd.

256-1 UEDA, NUMAZU-CITY SHIZUOKA-PREF., JAPAN
PHONE +81(55)966 0789
FAX +81(55)966 9192
E mail : alpha@micforg.co.jp
URL : http://www.micforg.co.jp

Alpha Novatech, Inc. - a subsidiary of Alpha Company.

473 Sapena Ct. #12 Santa Clara, CA 95054 USA
PHONE +1(408)567-8082
FAX +1(408)567-8053
E mail : sales@alphanovatech.com
URL : http://www.alphanovatech.com

ALPHA

Ultra - High Performance Heat Sink
For Z-Shaped CLIP / QSZ CLIP

ZZ60

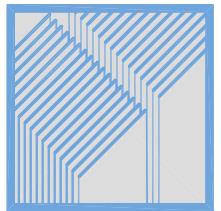

DIM

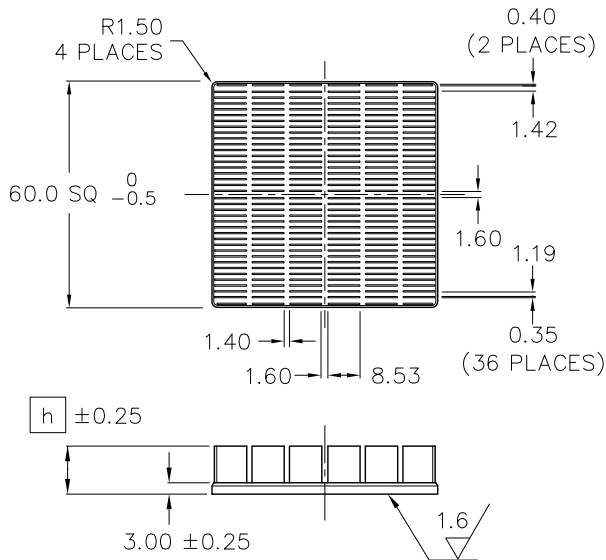

HEAT SINK
MATERIAL : A 6063
FINISH : BLACK ANODIZE

MODEL	HEIGHT h	WEIGHT (grams)
ZZ60-6.3B	6.3	34.7
ZZ60-9.5B	9.5	40.6
ZZ60-12.7B	12.7	46.4

Dimensions : mm

DATA

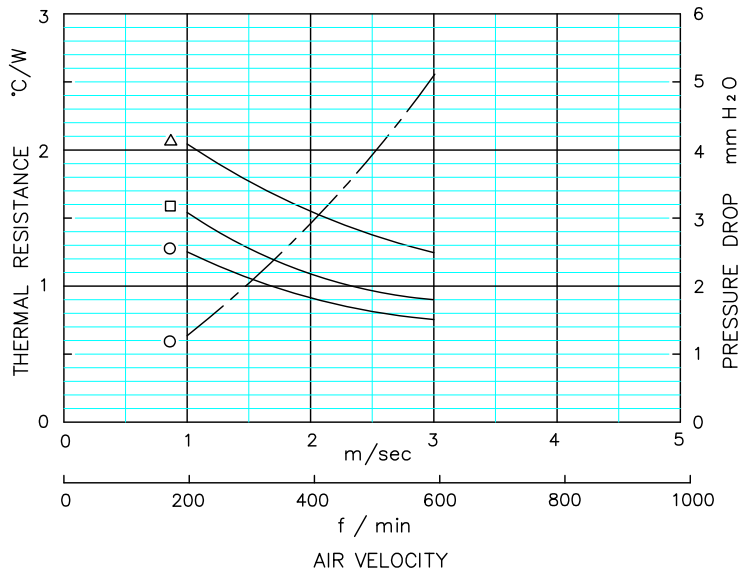

- △ ZZ60-6.3B
- ZZ60-9.5B
- ZZ60-12.7B

● DUCTED CONDITION
DUMMY HEATER SIZE: 12.7 SQ
THERMAL RESISTANCE ———
PRESURE DROP - - - - -

■ BASED ON ALPHA'S STANDARD TEST PROCEDURE.
REFER TO TECHNICAL INFORMATION.

Alpha Company Ltd.

256-1 UEDA, NUMAZU-CITY SHIZUOKA-PREF., JAPAN
PHONE +81(55)966 0789
FAX +81(55)966 9192
E mail : alpha@micforg.co.jp
URL : <http://www.micforg.co.jp>

Alpha Novatech, Inc. - a subsidiary of Alpha Company.

473 Sapena Ct. #12 Santa Clara, CA 95054 USA
PHONE +1(408)567-8082
FAX +1(408)567-8053
E mail : sales@alphanovatech.com
URL : <http://www.alphanovatech.com>